

# 349D2/D2 L

Hydraulic Excavator



## Engine

Engine Model	Cat® C13 ACERT™	
Engine Power (ISO 14396)	301 kW	403 hp
Net Power (SAE J1349/ISO 9249)	289 kW	387 hp

## Weights

Operating Weight		
Standard Undercarriage	45 382 kg	100,100 lb
Long Undercarriage	47 919 kg	105,600 lb



## 349D2/D2 L Differentiating Features

### Engine and Hydraulics

A powerful Cat C13 engine that meets U.S. EPA Tier 2, EU Stage II regulations, and China Tier 2 emission regulations combined with a highly efficient hydraulic system deliver excellent performance with low fuel consumption. In fact, the 349D2/D2 L uses up to 9 percent less fuel than its predecessor moving the same amount of material in optimized Economy Mode.

### Structures

Caterpillar design and manufacturing techniques assure you get outstanding durability and service life in the toughest applications.

### Operator Station

The spacious cab features excellent visibility and easy-to-access switches. The monitor features a full-color graphical display that is easy to see and use. Overall, the new cab provides you with a comfortable working environment for maximum production and efficiency.

### Reduced Service and Maintenance Cost

Routine service and maintenance can be completed quickly and easily to help you reduce ownership costs. Convenient access points, extended service intervals, and advanced filtration help keep downtime to a minimum.

### Complete Customer Support

Your Cat dealer offers a wide range of services that can be set up under a customer support agreement when you purchase your equipment.

### Total Solutions

Caterpillar and its extensive dealer network offer a wide variety of solutions designed to meet the unique needs of your business.

### Contents

Operator Station.....	4
Engine .....	6
Hydraulics .....	7
Structures and Undercarriage .....	8
Front Linkage .....	9
Service and Maintenance .....	10
Complete Customer Support.....	11
Work Tools.....	12
Integrated Technologies.....	14
Specifications.....	15
Standard Equipment.....	34
Optional Equipment.....	35







**The 349D2/D2 L offers outstanding performance, excellent control, high stick and bucket forces, impressive lift capacity, simplified service and a comfortable operator station to increase your productivity and lower operating costs.**



# Operator Station

Enhance your comfort, operation, and visibility.  
The 349D2/D2 L allows you to focus on your job.



## Operator Station

The ergonomically designed operator station is spacious, quiet, and comfortable, assuring high productivity during a long work day. All switches are located in front of the operator for convenient access.

## Cab Structure and Mounts

The cab shell is attached to the frame with viscous rubber mounts, which dampen vibrations and sound levels while enhancing your comfort. Thick steel tubing along the bottom perimeter improves the cab's resistance to fatigue and vibration.

## Seat

The suspension seat provides a variety of adjustments to accommodate a wide range of operators. The seat includes a reclining back, upper and lower seat slide adjustments, and height and tilt adjustments to meet your needs for comfort and productivity.

## Monitor

The monitor is a full-color Liquid Crystal Display (LCD) that has the capability of displaying information in 28 languages.

## Joystick Control and Console

Low-effort pilot-operated joystick controls are designed to match your natural wrist and arm position for maximum comfort and minimum fatigue. The right and left joystick console can be adjusted to meet your individual preferences, improving overall comfort and productivity during the course of a long work day.

## Climate Control

Positive filtered ventilation with a pressurized cab is standard. Fresh air or re-circulated air can be selected with a switch on the left console.

## Windows and Wipers

All glass is affixed directly to the cab to maximize visibility, eliminating window frames. The upper front windshield opens, closes, and stores on the roof above the operator with a one-touch action release system. Pillar-mounted wipers increase your viewing area and offer continuous and intermittent modes.

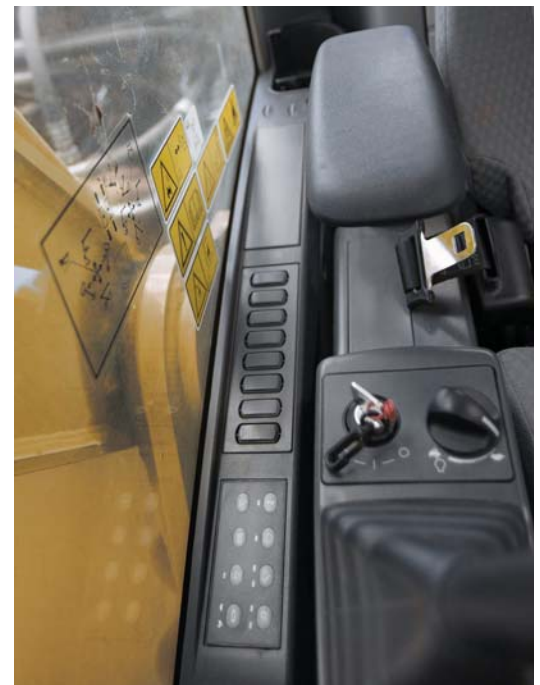





### **Turbocharger**

The Cat C13 uses a wastegate turbocharger for improved performance.

- The wastegate valve controls excessive engine boost pressure by allowing exhaust to bypass the exhaust-side turbine.
- The wastegate also reduces turbine wear in high RPM; low load conditions and optimizes air and fuel delivery for peak engine performance.
- The turbocharger increases the density of the air, enabling the engine to produce more power with few effects from altitude.

## **Engine**

Powerful, reliable, and fuel efficient to deliver more to your bottom line.

349D2/D2 L owning and operation costs have been reduced by reverting to optimized Economy Mode each time the machine is started regardless of what mode the operator had previously selected. This will help to reduce fuel consumption up to 9 percent than its predecessor moving the same amount of material.

### **Emission Standards**

The Cat C13 engine has been designed to meet U.S. EPA Tier 2, EU Stage II, and China Tier 2 emission standards. The engine incorporates proven robust components and precision manufacturing you can count on for reliable and efficient operation.

### **Fuel System**

The Cat C13 features electronic controls that govern the mechanically actuated unit fuel injection (MEUI™) system. MEUI provides the high-pressure required to deliver better fuel economy through finer fuel atomization and more complete combustion.

### **ADEM™ A4 Engine Controller**

The ADEM A4 electronic control module manages fuel delivery to get the best performance per liter of fuel used. The engine management system provides flexible fuel mapping, allowing the engine to respond quickly to varying application needs. It tracks engine and machine conditions while keeping the engine operating at peak efficiency.

### **Air Cleaner**

The radial seal air filter features a double-layered filter core for more efficient filtration and is located in a compartment behind the cab. A warning is displayed on the monitor when dust accumulates above a preset level.

### **Low Sound and Vibration Levels**

The engine mounts are rubber-isolating mounts matched with the engine package to provide optimum sound and vibration reduction. Further noise reduction has been achieved through design changes to the isolated top cover, oil pan, multiple injection strategy, insulated timing cover, sculpted crankcase.



# Hydraulics

Uncanny power and control for your multiple applications.

## Pilot System

An independent pilot pump enables smooth, precise control for the front linkage, swing, and travel operations.

## Component Layout

The component location and hydraulic system design provide the highest level of system efficiency. The main pumps, control valve and hydraulic tank are located as close to each other as possible. This design makes it possible to use shorter tubes and lines between components, reducing friction losses and pressure drops.

## Hydraulic Cross-Sensing System

The hydraulic cross sensing system utilizes each of two hydraulic pumps to 100 percent of engine power under all operating conditions. This improves productivity with faster implement speeds and quicker, stronger pivot turns.

## Boom and Stick Regeneration Circuits

A hydraulically operated stick regeneration circuit saves energy and improves multi-function performance during the stick-in operation. The boom regeneration circuit is operated electrically, and this system is managed by the machine ECM. The system improves cycle times and fuel efficiency, increasing your productivity and reducing operating costs.

## Boom and Swing Priority

The hydraulic system on the 349D2/D2 L provides automatic priority function for boom-up and swing operations eliminating the need for work mode buttons. When the boom or swing lever is activated, the system automatically assigns priority based on operator demand.

## Hydraulic Cylinder Snubbers

Snubbers are located at the rod-end of the boom cylinders and both ends of the stick cylinders to cushion shocks while reducing sound levels and extending component and structure life.

# Structures and Undercarriage

Strong and durable, all you expect from Cat excavators.



## Main Frame

The rugged main frame is built to perform in the toughest applications. The X-shaped, box-section carbody provides excellent resistance to torsional bending, and press-formed, robot-welded track roller frames provide exceptional strength and durability.

## Fixed Gauge Undercarriages

The 349D2 standard (fixed gauge undercarriage) and 349D2 L (long and fixed gauge undercarriage) contribute significantly to outstanding stability and durability.

## Rollers and Idlers

Sealed and lubricated track rollers, carrier rollers, and idlers provide excellent service life to keep your machine in the field and working longer.

## Track Roller Frame

The track roller frame is made of a press-formed, pentagonal section that is robot-welded for weld consistency and quality. The track frame has been designed so that the top of the track frame has a steep angle to help prevent accumulation of mud and debris.

## Counterweights

The 9.0 mt (9.9 t) counterweight maintains large lifting capacity and excellent stability. It's bolted directly to the main frame for extra rigidity.

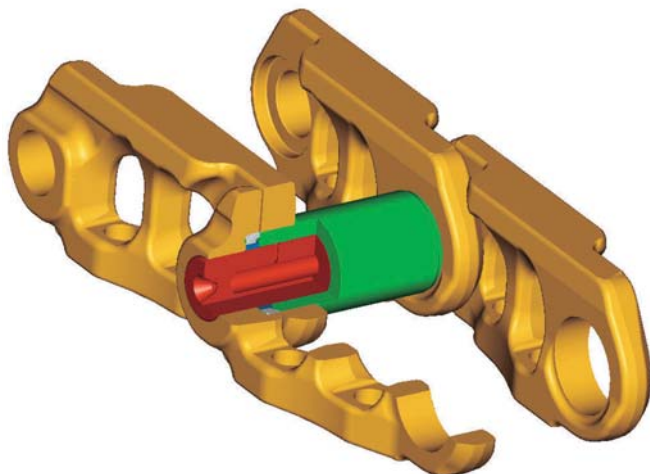

## Track

Durable Cat undercarriage absorbs stress and provides excellent stability. The 349D2/D2 L comes standard with grease lubricated tracks. The track links are assembled and sealed with grease to decrease internal bushing wear, reduce travel noise and extend service life lowering operating costs.



# Front Linkage

Reliable, durable, and versatile to meet all your application needs.

## Booms and Sticks

The 349D2/D2 L is offered with a range of booms and sticks. Each is built with internal baffle plates and stress-relieved for added durability, and each undergoes ultrasound inspection to ensure quality and reliability. Large box-section structures with thick, multi-plate fabrications, castings, and forgings are used in high-stress areas such as the boom nose, boom foot, boom cylinder, and stick foot to improve durability. Also, the boom nose pin retention method is a captured flag design for enhanced durability.

## Reach Front Linkage

The Reach boom is designed to balance reach, digging force bucket capacity, offering a wide range of applications as digging, loading and trenching.

There are three reach stick options available to meet all your application requirements:

- The 2.9 m (9'6") stick is best used when you are working primarily in truck loading applications to maximize your breakout force and increase your bucket fill factor.
- The 3.35 m (11'0") stick is a versatile option that will meet the needs for most of your construction applications.
- The 3.9 m (12'10") stick is a great choice when you need additional working range like truck loading and deep trenching.



## Mass Front Linkage

The mass excavation (ME) front linkage is designed to maximize machine performance through superior digging forces and a larger bucket capacity. The 6.55 m (21'6") mass excavation boom is reinforced with a large cross section for longer life and durability.

The ME boom has two stick options to meet your demanding applications:

- The 2.5 m (8'2") ME stick is best for bench loading. This option also provides better breakout force for ripper and is ideal for hammer applications.
- The 3.0 m (9'10") ME stick is best when you primarily use high-capacity buckets in truck loading applications to maximize your breakout force.



# Service and Maintenance

Simplified service and maintenance save you time and money.

## Extended Service Intervals

Extended service and maintenance intervals increase machine availability. The maintenance intervals for engine oil and engine oil filter have been extended to 500 hours.

## Capsule Filter

The hydraulic return filters are located in the hydraulic tank. The filter elements are removable without spilling hydraulic oil.

## Pilot Hydraulic System Filter

Pilot hydraulic system filter keeps contaminants from the pilot system and is located in the pump compartment.

## Radial Seal Main Air Cleaner

Radial seal main air cleaner with precleaner has a double-layered filter element for more efficient filtration. No tools are required to change the element.

## Fuel-Water Separator

The water separator has a primary fuel filter element and is located in the air cleaner compartment for easy access from the ground.

## Service Points

Service points are centrally located with easy access to facilitate routine maintenance.

## Oil Sample and Pressure Ports

Oil sample and pressure ports provide easy checking of machine condition and are standard on every machine.

## Greasing Points

A concentrated remote greasing block on the boom delivers grease to hard-to-reach locations.

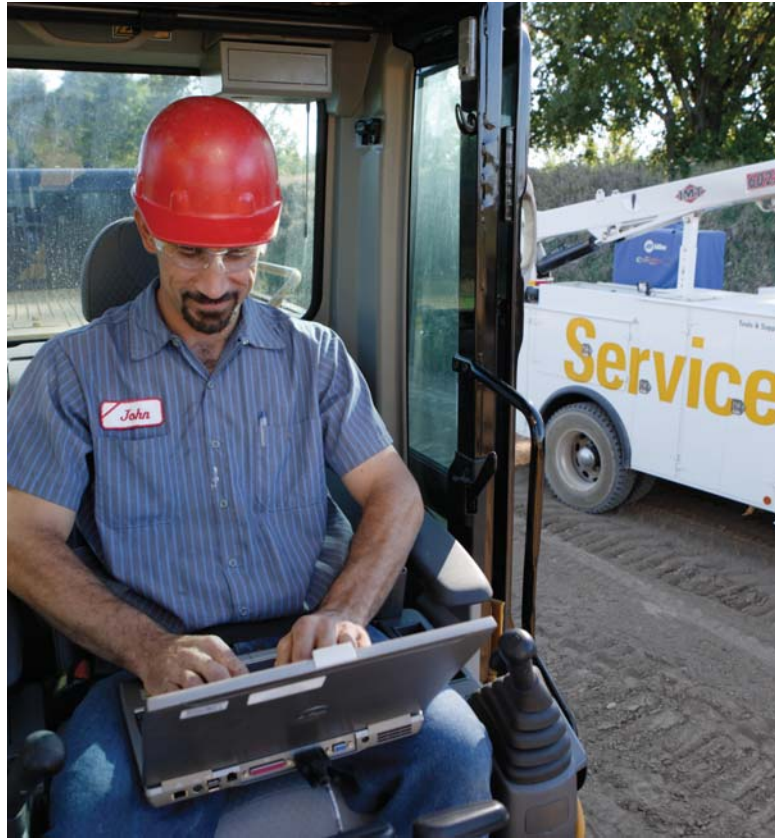



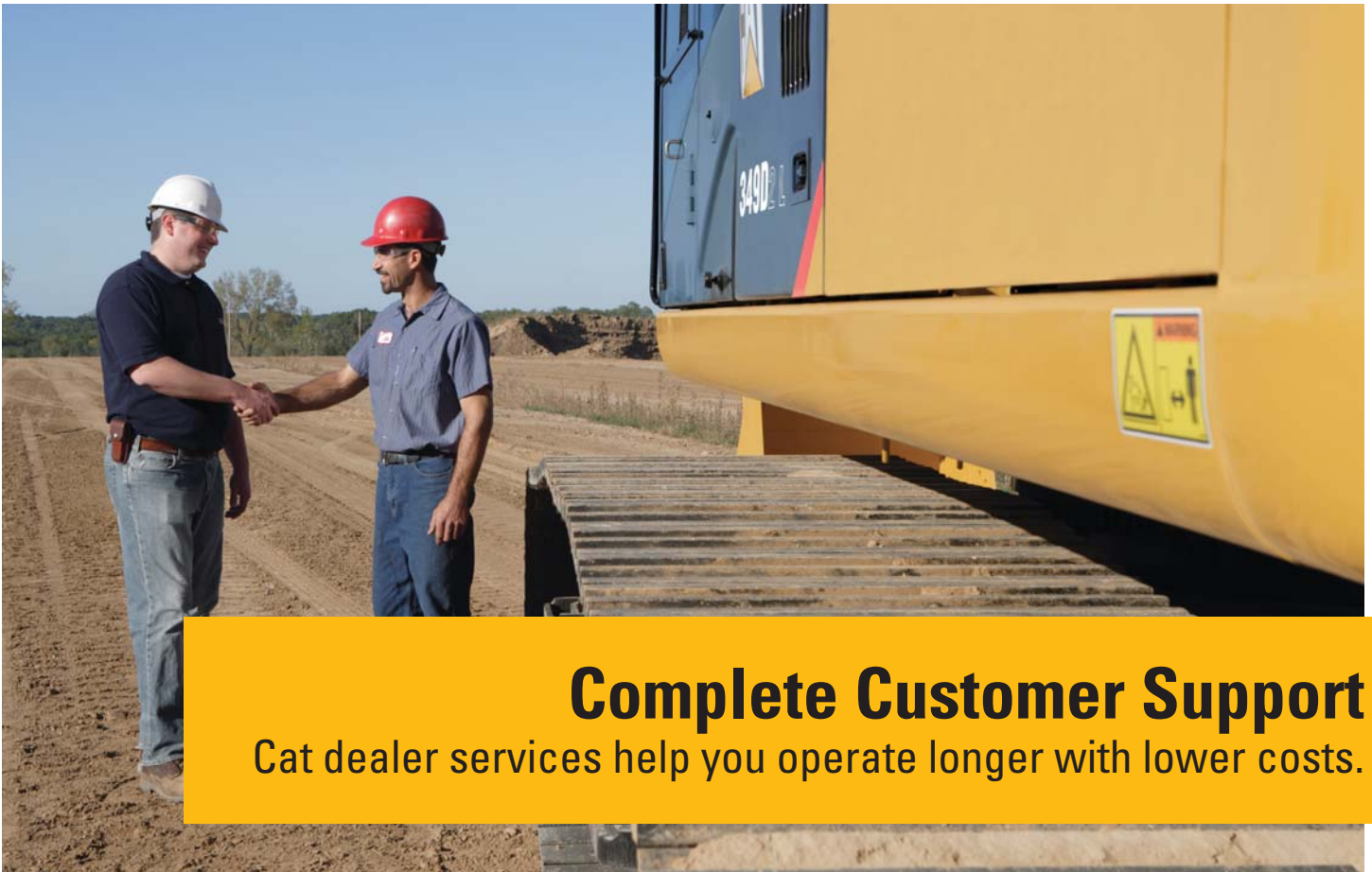

# Complete Customer Support

Cat dealer services help you operate longer with lower costs.

## **Product Support**

Cat dealers utilize a worldwide computer network to find in-stock parts to minimize machine downtime. You can also save money with our line of remanufactured components.

## **Machine Selection**

Your Cat dealers can provide specific recommendations with detailed comparisons of the Cat machines you are considering before you buy. This ensures you get the right size machine and appropriate work tools to meet all of your application needs.

## **Maintenance Services**

Repair option programs guarantee the cost of repairs up front. Condition monitoring services and diagnostic programs such as scheduled oil sampling, coolant sampling, and technical analysis help you avoid unscheduled repairs.

## **Customer Support Agreements**

Cat dealers offer a variety of product support agreements that can be tailored to meet your specific needs. These plans can cover the entire machine – including attachments – to help protect your investment.

## **Replacement**

Repair, rebuild, or replace? Your Cat dealers can help you evaluate the costs involved so you can make the right choice.



# Work Tools

Dig, hammer, rip, and cut with confidence.



1



2



3



4



5

## Versatility and Performance

Each Cat work tool is designed to optimize the versatility and performance of your machine. An extensive range of buckets, compactors, grapples, multi-processors, rippers, crushers, pulverizers, hammers, and shears is available for your 349D2/D2 L.

## Buckets and GET

Cat buckets and Cat Ground Engaging Tools (GET) are designed and matched to the machine to ensure optimal performance and fuel efficiency.

## Utility Buckets (UD)

UD buckets are for digging in low-impact, low-abrasive material such as dirt, loam, and clay.

## General-Duty Buckets (GD)

GD buckets are for digging in low-impact, moderately abrasive materials such as dirt, loam, gravel, and clay.

## Heavy-Duty Buckets (HD)

HD buckets are a good starting point when application conditions vary – especially when conditions include mixed dirt, clay, sand, and gravel.

## Severe-Duty Buckets (SD)

SD buckets are best suited to highly abrasive materials like shot rock, sand stone, and granite.

## Extreme-Duty Buckets (XD)

XD buckets are for extremely abrasive materials like high-quartzite granite.

- 1) Utility Buckets (UD)
- 2) General-Duty Buckets (GD)
- 3) Heavy-Duty Buckets (HD)
- 4) Severe-Duty Buckets (SD)
- 5) Extreme-Duty Buckets (XD)



## Couplers

Quick couplers allow one person to change work tools in seconds for maximum performance and flexibility on a job site. One machine can move rapidly from task to task, and a fleet of similarly equipped machines can share a common work tool inventory.

### Center-Lock™ Pin Grabber Coupler

Center-Lock is a pin grabber coupler and features a patent-pending locking system. A highly visible secondary lock clearly shows the operator when the coupler is engaged or disengaged from the bucket or work tool.

## E Series Hammers

E Series hammers bring together customer expectations for performance, quality, and serviceability along with Caterpillar manufacturing expertise. They are also quiet – a significant benefit in urban and noise-restricted work areas.

## Rippers

Constructed from high-strength steels and built to last, Cat rippers endure in the toughest conditions. The box-section structure is reinforced for maximum rigidity, transmitting the full machine power to the material being ripped. Rippers feature a replaceable wear tip, and most models also come equipped with a replaceable shank protector.

## Grapples

Cat grapples make Cat excavators the ideal machine for handling loose material, sorting trash, and demolition site cleanup. An array of styles and sizes is available to match excavators to the task at hand.

## Multi-Processors

Multi-processors do the work of many types of demolition tools by use of interchangeable jaw sets. Changing jaws allows a single unit to crush, pulverize, and perform a variety of specialized tasks such as cutting steel rebar and tanks.

## Shears

Cat shears are designed to take full advantage of the hydraulic flows and pressures produced by Cat excavators – all to enhance productivity without compromising safety or causing premature wear of the shear or carrier.

## Pulverizers

Mechanical pulverizers are cost-effective tools for recycling demolished concrete debris. The bucket cylinder on the excavator powers the pulverizer, eliminating the need for a dedicated cylinder, associated hydraulics, and additional installation cost.

## Compactors

Cat compactors make job site compaction quick, efficient, and cost effective.

## Crushers

The hydraulic concrete crusher is well suited for demolition in residential areas. The tool combines several demolition operations in one piece of equipment:

- Breaking out concrete from fixed structures
- Pulverizing concrete
- Cutting reinforcement rods and small steel profiles



# Integrated Technologies

Monitor, manage, and enhance your job site operations

Cat Connect makes smart use of technology and services to improve your job site efficiency. Using the data from technology-equipped machines, you'll get more information and insight into your equipment and operations than ever before.

Cat Connect technologies offer improvements in these key areas:



EQUIPMENT MANAGEMENT

**Equipment Management** – increase uptime and reduce operating costs.



PRODUCTIVITY

**Productivity** – monitor production and manage job site efficiency.



SAFETY

**Safety** – enhance job site awareness to keep your people and equipment safe.

Featured Cat Connect technologies include:

## Link

LINK technologies wirelessly connect you to your equipment giving you access to essential information you need to know to run your business. Link data can give you valuable insight into how your machine or fleet is performing so you can make timely, fact-based decisions that can boost job site efficiency and productivity.

- **Product Link™/VisionLink®** – Product Link is deeply integrated into your machine, helping to take the guesswork out of equipment management. Easy access to timely information like machine location, hours, fuel usage, idle time and event codes via the online VisionLink user interface can help you effectively manage your fleet and lower operating costs.

## Grade

GRADE technologies combine digital design data, in-cab guidance and automatic machine control to help operators hit target grade faster and finish jobs quickly, accurately, and in fewer passes – improving grading productivity and efficiency with less rework.

- **Cat AccuGrade™** – The dealer-installed AccuGrade system provides operators an easy-to-read display to deliver real-time cut/fill data to guide operators to grade quickly. Experienced operators can maintain peak efficiency levels throughout the work day, and less experienced operators can be more productive faster. AccuGrade reduces grade checking and staking, labor and material costs, and improves job site safety.
- Caterpillar offers a choice of:
  - Depth and Slope Guidance – for simple 2D planes and slopes
  - Global Navigation Satellite System – for complex 3D designs
- **AccuGrade Ready Option (ARO)** – The factory AccuGrade Ready Option provides optimal mounting locations, brackets, and hardware to make the AccuGrade installation quick and easy. Deep integration optimizes machine and system performance and productivity.

## Detect

DETECT technologies combine safety features, functionalities and alerts to enhance your job site awareness and keep your people and assets safe.



## CAT CONNECT



- **Rearview Camera** – Rear vision cameras greatly enhance visibility behind the machine, helping the operator work more safely and productively. The camera view is automatically displayed on the integrated in-cab monitor increasing awareness of the working area around the machine giving the operator the confidence to work more safely and efficiently, at maximum potential.

**Note:** Availability may vary by region. Please consult your Cat dealer for details.



# 349D2/D2 L Hydraulic Excavator Specifications

## Engine

Engine Model	Cat C13 ACERT	
Engine Power (ISO 14396)	301 kW	403 hp
Net Power (SAE J1349/ISO 9249)	289 kW	387 hp
Bore	130 mm	5.11 in
Stroke	157 mm	6.18 in
Displacement	12.5 L	762 in <sup>3</sup>

- The Cat C13 meets exhaust emissions equivalent to U.S. EPA Tier 2, EU Stage II, and China Tier 2 emission regulations.
- Net power advertised is the power available at the flywheel when the engine is equipped with fan, air cleaner, muffler, and alternator.
- The field-proven C13 engine can work efficiently at altitudes up to 2300 m (7,500 ft).

## Weights

Operating Weight		
Standard Undercarriage*	45 382 kg	100,100 lb
Long Undercarriage**	47 919 kg	105,600 lb

\*Standard Undercarriage: Counterweight – 9.0 mt (9.9 t), Reach Boom – 6.9 m (22'8"), Stick – R3.9 m (12'10"), Track Shoe – Standard 750 mm (30 in) Triple Grouser, Bucket – TB2.2 m<sup>3</sup> (2.88 yd<sup>3</sup>)

\*\*Long Undercarriage: Counterweight – 9.0 mt (9.9 t), Mass Boom – 6.55 m (21'6"), Stick – M3.0 m (9'10"), Track Shoe – Long Fixed Gauge, 900 mm (35 in) Triple Grouser, Bucket – UB2.4 m<sup>3</sup> (3.16 yd<sup>3</sup>)

## Track

Number of Shoes (each side)	
Standard	49
Long	52
Number of Track Rollers (each side)	
Standard	8
Long	9
Number of Carrier Rollers (each side)	
Standard	2
Long	2

## Swing Mechanism

Swing Speed	8.7 rpm	
Swing Torque	149 kN·m	109,896 lbf·ft

## Drive

Gradeability	30°/70%	
Maximum Travel Speed	4.5 km/h	2.7 mph
Maximum Drawbar Pull	338 kN	75,985 lbf

## Hydraulic System

Main System – Maximum Flow (Total)	734 L/min	193 gal/min
Maximum Pressure – Equipment	35 000 kPa	5,076 psi
Maximum Pressure – Travel	35 000 kPa	5,076 psi
Maximum Pressure – Swing	31 400 kPa	4,554 psi
Pilot System – Maximum Flow	43 L/min	11.3 gal/min
Pilot System – Maximum Flow	43 L/min	2,623 in <sup>3</sup> /min
Pilot System – Maximum Pressure	4110 kPa	596 psi
Boom Cylinder – Bore	160 mm	6.0 in
Boom Cylinder – Stroke	1575 mm	62.0 in
Stick Cylinder – Bore	190 mm	7.0 in
Stick Cylinder – Stroke	1778 mm	70.0 in
TB Bucket Cylinder – Bore	160 mm	6.0 in
TB Bucket Cylinder – Stroke	1356 mm	53.0 in
UB Bucket Cylinder – Bore	170 mm	6.0 in
UB Bucket Cylinder – Stroke	1396 mm	55.0 in

## Service Refill Capacities

Fuel Tank Capacity	705 L	186 gal
Cooling System	35.5 L	9 gal
Engine Oil (with filter)	42 L	11 gal
Swing Drive (each)	10 L	2 gal
Final Drive (each)	15 L	3 gal
Hydraulic System (including tank)	570 L	150 gal
Hydraulic Tank	243 L	64 gal

## Sound Performance

Performance	ANSI/SAE J1166 MAY90 Meets OSHA and MSHA Requirements
-------------	---

# 349D2/D2 L Hydraulic Excavator Specifications

## Dimensions

All dimensions are approximate.

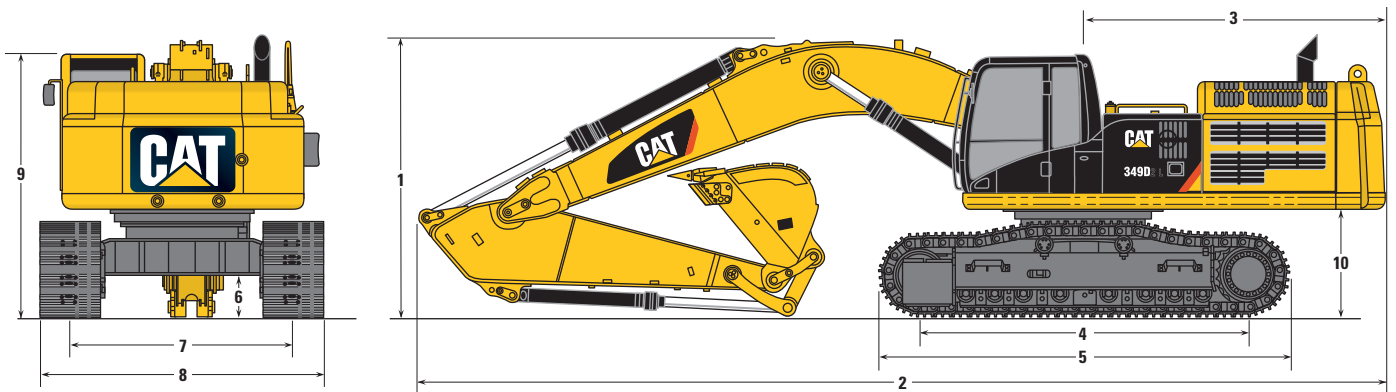

Boom Options	Reach Boom 6.9 m (22'8")			Mass Boom 6.55 m (21'6")	
Stick Options	R2.9TB (9'6")	R3.35TB (11'0")	R3.9TB (12'10")	M2.5UB (8'2")	M3.0UB (9'10")
	mm (ft)	mm (ft)	mm (ft)	mm (ft)	mm (ft)
<b>1</b> Shipping Height	3700 (12'2")	3550 (11'6")	3700 (12'1")	3960 (13'0")	3990 (13'1")
<b>2</b> Shipping Length	11 870 (38'11")	11 890 (39'0")	11 890 (39'0")	11 630 (38'2")	11 550 (37'9")
<b>3</b> Tail Swing Radius	3690 (12'1")	3690 (12'1")	3690 (12'1")	3690 (12'1")	3690 (12'1")
<b>4</b> Length to Center of Idler and Sprocket					
Standard Undercarriage	4030 (13'3")	4030 (13'3")	4030 (13'3")	4030 (13'3")	4030 (13'3")
Long Undercarriage	4360 (14'4")	4360 (14'4")	4360 (14'4")	4360 (14'4")	4360 (14'4")
<b>5</b> Track Length					
Standard Undercarriage	5070 (16'8")	5070 (16'8")	5070 (16'8")	5070 (16'8")	5070 (16'8")
Long Undercarriage	5370 (17'6")	5370 (17'6")	5370 (17'6")	5370 (17'6")	5370 (17'6")
<b>6</b> Ground Clearance*					
Standard Undercarriage	510 (1'8")	510 (1'8")	510 (1'8")	510 (1'8")	510 (1'8")
Long Undercarriage	510 (1'8")	510 (1'8")	510 (1'8")	510 (1'8")	510 (1'8")
<b>7</b> Track Gauge					
Standard Undercarriage	2740 (9'0")	2740 (9'0")	2740 (9'0")	2740 (9'0")	2740 (9'0")
Long Undercarriage	2740 (9'0")	2740 (9'0")	2740 (9'0")	2740 (9'0")	2740 (9'0")
<b>8</b> Transport Width					
Standard/Long Undercarriage					
600 mm (24 in) Shoes	3430 (11'3")	3430 (11'3")	3430 (11'3")	3430 (11'3")	3430 (11'3")
750 mm (30 in) Shoes	3490 (11'5")	3490 (11'5")	3490 (11'5")	3490 (11'5")	3490 (11'5")
900 mm (35 in) Shoes	3640 (11'11")	3640 (11'11")	3640 (11'11")	3640 (11'11")	3640 (11'11")
<b>9</b> Cab Height					
Standard/Long Undercarriage	3220 (10'6")	3220 (10'6")	3220 (10'6")	3220 (10'6")	3220 (10'6")
<b>10</b> Counterweight Clearance**					
Standard/Long Undercarriage	1280 (4'2")	1280 (4'2")	1280 (4'2")	1280 (4'2")	1280 (4'2")

\*Including shoe lug height.

\*\*Without shoe lug height.



# 349D2/D2 L Hydraulic Excavator Specifications

## Working Ranges

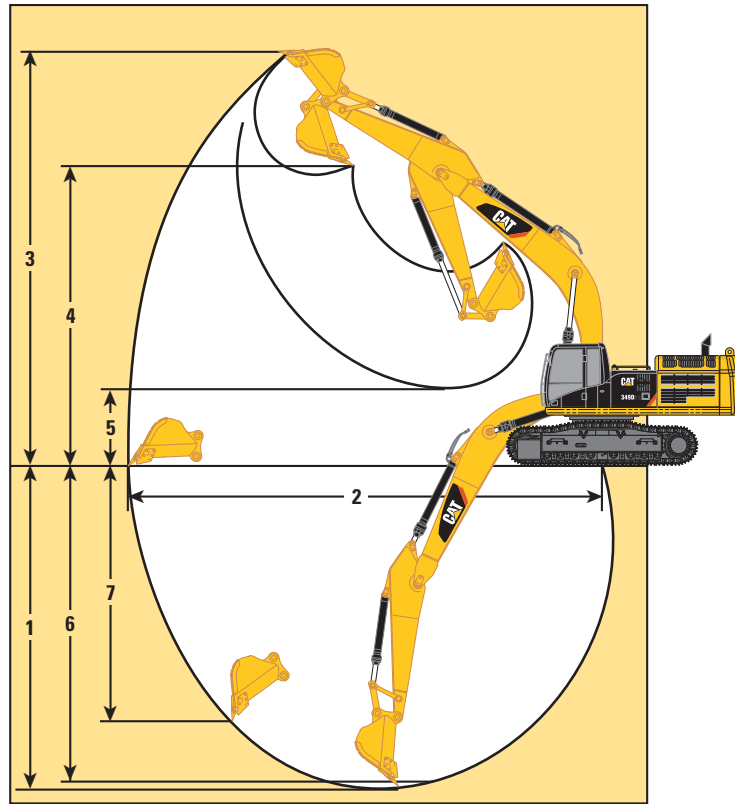

Boom Options	Reach Boom 6.9 m (22'8")			Mass Boom 6.55 m (21'6")	
	R2.9TB (9'6")	R3.35TB (11'0")	R3.9TB (12'10")	M2.5UB (8'2")	M3.0UB (9'10")
Stick Options	mm (ft)	mm (ft)	mm (ft)	mm (ft)	mm (ft)
1 Maximum Digging Depth	7150 (23'5")	7600 (24'11")	8150 (26'9")	6720 (22'1")	7220 (23'8")
2 Maximum Reach at Ground Level	11 240 (36'11")	11 660 (38'3")	12 080 (39'8")	10 710 (35'2")	11 180 (36'8")
3 Maximum Cutting Height	10 620 (34'10")	10 800 (35'5")	10 710 (35'2")	10 230 (33'7")	10 420 (34'2")
4 Maximum Loading Height	7290 (23'11")	7470 (24'6")	7450 (24'5")	6620 (21'9")	6810 (22'4")
5 Minimum Loading Height	3250 (10'8")	2800 (9'2")	2250 (7'5")	3160 (10'4")	2660 (8'9")
6 Maximum Depth Cut for 2440 mm (8'0") Level Bottom	6990 (22'11")	7460 (24'6")	8020 (26'4")	6550 (21'6")	7070 (23'2")
7 Maximum Vertical Wall Digging Depth	5870 (19'3")	6300 (20'8")	6460 (21'2")	4920 (16'2")	5380 (17'8")

# 349D2/D2 L Hydraulic Excavator Specifications

## Operating Weight and Ground Pressure

	600 mm (24 in) Double Grouser Shoes		600 mm (24 in) Triple Grouser Shoes		750 mm (30 in) Double Grouser Shoes		750 mm (30 in) Triple Grouser Shoes		900 mm (35 in) Triple Grouser Shoes	
	kg (lb)	kPa (psi)	kg (lb)	kPa (psi)	kg (lb)	kPa (psi)	kg (lb)	kPa (psi)	kg (lb)	kPa (psi)
<b>Standard Fix Undercarriage</b>										
Reach Boom – 6.9 m (22'8")										
R2.9TB (9'6")	—	—	—	—	44 600 (98,300)	66.2 (9.63)	44 400 (97,900)	66.2 (9.59)	—	—
R3.35TB (11'0")	—	—	—	—	44 600 (98,300)	66.3 (9.63)	44 500 (98,100)	66.3 (9.61)	—	—
R3.9TB (12'10")	—	—	—	—	44 600 (98,300)	66.2 (9.63)	44 500 (98,100)	66.2 (9.61)	—	—
Mass Boom – 6.55 m (21'6")										
M2.5UB (8'2")	—	—	—	—	45 900 (101,200)	68.2 (9.91)	45 800 (101,000)	68.2 (9.89)	—	—
M3.0UB (9'10")	—	—	—	—	46 000 (101,400)	68.3 (9.93)	45 900 (101,200)	68.3 (9.91)	—	—
<b>Long Fix Undercarriage</b>										
Reach Boom – 6.9 m (22'8")										
R2.9TB (9'6")	44 500 (98,100)	77.2 (11.19)	44 400 (97,900)	77.0 (11.16)	44 500 (98,100)	61.8 (8.95)	45 200 (99,600)	62.6 (9.09)	45 900 (101,200)	53.1 (7.69)
R3.35TB (11'0")	44 400 (97,900)	77.1 (11.16)	44 300 (97,700)	76.9 (11.14)	44 500 (98,100)	61.7 (8.95)	45 100 (99,400)	62.5 (9.07)	45 800 (101,000)	53.0 (7.67)
R3.9TB (12'10")	44 400 (97,900)	77.0 (11.16)	44 300 (97,700)	76.8 (11.14)	44 500 (98,100)	61.7 (8.95)	45 100 (99,400)	62.5 (9.07)	45 800 (101,000)	53.0 (7.67)
Mass Boom – 6.55 m (21'6")										
M2.5UB (8'2")	45 800 (101,000)	79.4 (11.51)	45 700 (100,800)	79.2 (11.49)	45 800 (101,000)	63.6 (9.21)	46 400 (102,300)	64.4 (9.35)	47 200 (104,100)	54.5 (7.91)
M3.0UB (9'10")	45 900 (101,200)	79.5 (11.54)	45 800 (101,000)	79.4 (11.51)	45 900 (101,200)	63.7 (9.23)	46 500 (102,500)	64.5 (9.35)	47 300 (104,300)	54.6 (7.93)



# 349D2/D2 L Hydraulic Excavator Specifications

## Major Component Weights\*

	kg (lb)
Base Machine (with boom cylinder, without counterweight, front linkage and track)	
Standard Fix Undercarriage	22 731 (50,100)
Long Fix Undercarriage	23 001 (50,700)
Counterweight	
9.0 mt (9.9 t)	9000 (19,800)
Boom (includes lines, pins and stick cylinder)	
Reach Boom – 6.9 m (22'8")	4081 (9,000)
Mass Boom – 6.55 m (21'6")	4602 (10,100)
Stick (includes lines, pins and bucket cylinder)	
R2.9TB (9'6")	1952 (4,300)
R3.35TB (11'0")	1994 (4,400)
R3.9TB (12'10")	2119 (4,700)
M2.5UB (8'2")	2189 (4,800)
M3.0UB (9'10")	2370 (5,200)
Track Shoe (Standard Fix Undercarriage/per two tracks)	
750 mm (30 in) Triple Grouser Shoes	5529 (12,200)
Track Shoe (Long Fix Undercarriage/per two tracks)	
600 mm (24 in) Double Grouser Shoes	5222 (11,500)
600 mm (24 in) Triple Grouser Shoes	5117 (11,300)
750 mm (30 in) Double Grouser Shoes	6006 (13,200)
750 mm (30 in) Triple Grouser Shoes	5868 (12,900)
900 mm (35 in) Triple Grouser Shoes	6620 (14,600)
Buckets	
TB1758X – 2.2 m <sup>3</sup> (2.88 yd <sup>3</sup> )	1922 (4,200)
UB1729X – 2.4 m <sup>3</sup> (3.16 yd <sup>3</sup> )	2326 (5,100)

\*Base machine includes 75 kg (165 lb) operator weight, 90% fuel weight, and undercarriage with center guard.

**Note:** All weights are rounded up to nearest 10 kg and lb except for quick coupler and buckets.

Kg and lb were rounded up separately so some of the kg and lb do not match.

# 349D2/D2 L Hydraulic Excavator Specifications

## Bucket and Stick Forces

Reach Boom 6.9 m (22'8")	R3.9TB (12'10")		R3.35TB (11'0")		R2.9TB (9'6")	
	kN	(lbf)	kN	(lbf)	kN	(lbf)
<b>TB-Family Bucket</b>						
Heavy Duty						
Bucket Digging Force (ISO)	267	(60,100)	267	(60,100)	267	(60,100)
Stick Digging Force (ISO)	184	(41,400)	201	(45,200)	221	(49,600)
Bucket Digging Force (SAE)	238	(53,500)	238	(53,500)	238	(53,500)
Stick Digging Force (SAE)	180	(40,400)	195	(43,900)	214	(48,100)
Severe Duty						
Bucket Digging Force (ISO)	267	(60,100)	267	(60,100)	267	(60,100)
Stick Digging Force (ISO)	184	(41,400)	201	(45,200)	221	(49,600)
Bucket Digging Force (SAE)	238	(53,500)	238	(53,500)	238	(53,500)
Stick Digging Force (SAE)	180	(40,400)	195	(43,900)	214	(48,100)
<b>Mass Boom 6.55 m (21'6")</b>						
	M3.0UB (9'10")		M2.5UB (8'2")			
	kN	(lbf)	kN	(lbf)		
<b>UB-Family Bucket</b>						
General Duty						
Bucket Digging Force (ISO)	298	(66,900)	298	(66,900)		
Stick Digging Force (ISO)	211	(47,300)	239	(53,700)		
Bucket Digging Force (SAE)	258	(57,900)	258	(57,900)		
Stick Digging Force (SAE)	201	(45,200)	226	(50,900)		
Heavy Duty						
Bucket Digging Force (ISO)	295	(66,300)	295	(66,300)		
Stick Digging Force (ISO)	210	(47,200)	238	(53,500)		
Bucket Digging Force (SAE)	256	(57,400)	256	(57,400)		
Stick Digging Force (SAE)	200	(45,000)	226	(50,700)		
Severe Duty						
Bucket Digging Force (ISO)	290	(65,200)	290	(65,200)		
Stick Digging Force (ISO)	211	(47,500)	239	(53,800)		
Bucket Digging Force (SAE)	252	(56,600)	252	(56,600)		
Stick Digging Force (SAE)	203	(45,700)	229	(51,500)		



# 349D2/D2 L Hydraulic Excavator Specifications

## Reach Boom (Standard Fix Undercarriage) Lift Capacities – Counterweight: 9.0 mt (9.9 t) – Heavy Lift: Off

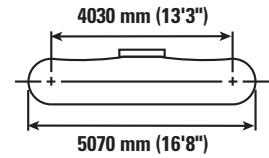
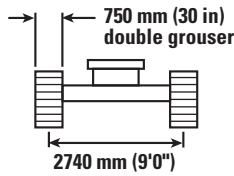
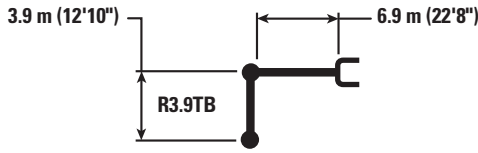

		1500 mm/60 in		3000 mm/120 in		4500 mm/180 in		6000 mm/240 in		7500 mm/300 in		9000 mm/360 in		mm inch		
9000 mm 360 in	kg lb													*7250 *16,100	*7250 *16,100	7870 310
7500 mm 300 in	kg lb													*6950 *15,300	*6950 *15,300	8980 350
6000 mm 240 in	kg lb								*9750 *21,200	*9750 *21,200	*9150 *20,000	8000 17,150	*6850 *15,100	*6850 *15,100	9720 390	
4500 mm 180 in	kg lb							*12 450 *26,900	*12 450 *26,900	*10 650 *23,100	10 350 22,300	*9550 *20,850	7800 16,750	*7000 *15,350	6350 13,950	10 190 400
3000 mm 120 in	kg lb					*19 800 *42,500	*19 800 *42,500	*14 400 *31,100	13 650 29,450	*11 700 *25,350	9900 21,300	*10 150 *22,000	7500 16,150	*7300 *16,050	5950 13,150	10 420 410
1500 mm 60 in	kg lb					*22 600 *48,700	19 300 41,600	*16 050 *34,700	12 850 27,750	*12 650 *27,450	9400 20,300	10 600 22,850	7250 15,600	*7850 *17,250	5850 12,800	10 430 410
0 mm 0 in	kg lb			*19,600	*19,600	*22 550 *50,750	18 600 40,050	*17 000 *36,750	12 350 26,550	*13 300 *28,750	9050 19,550	10 400 22,400	7050 15,150	8700 19,100	5900 13,000	10 210 410
-1500 mm -60 in	kg lb			*14 550 *32,750	*14 550 *32,750	*22 900 *49,600	18 400 39,550	*17 050 *36,900	12 050 26,000	13 300 28,650	8900 19,100	10 300 22,150	6950 14,950	9200 20,250	6250 13,700	9760 390
-3000 mm -120 in	kg lb	*36,650	*36,650	*21 200 *47,850	*21 200 *47,850	*21 250 *46,000	18 500 39,750	*16 200 *35,050	12 050 25,900	*12 750 *27,500	8850 19,050	*9950	6950	*9900 *21,800	6950 15,300	9040 360
-4500 mm -180 in	kg lb			*24 250 *52,300	*24 250 *52,300	*18 350 *39,500	*18 350 *39,500	*14 200 *30,500	12 200 26,350	*10 900 *23,150	9000 19,450			*9900 *21,750	8350 18,600	7960 310
-6000 mm -240 in	kg lb					*13 400 *28,200	*13 400 *28,200	*10 100 *20,800	*10 100 *20,800					*9200 *20,050	*9200 *20,050	6360 250



ISO 10567



\*Indicates that the load is limited by hydraulic lifting capacity rather than tipping load. The above loads are in compliance with hydraulic excavator lift capacity standard ISO 10567:2007. They do not exceed 87% of hydraulic lifting capacity or 75% of tipping load. Weight of all lifting accessories must be deducted from the above lifting capacities. Lifting capacities are based on the machine standing on a firm, uniform supporting surface. The use of a work tool attachment point to handle/lift objects, could affect the machine lift performance.

Lift capacity stays with ±5% for all available track shoes.

Always refer to the appropriate Operation and Maintenance Manual for specific product information.

# 349D2/D2 L Hydraulic Excavator Specifications

## Reach Boom (Standard Fix Undercarriage) Lift Capacities – Counterweight: 9.0 mt (9.9 t) – Heavy Lift: Off

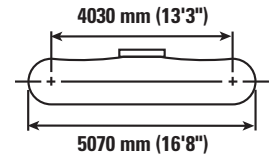
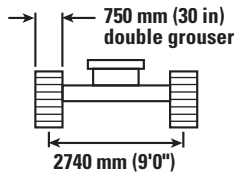
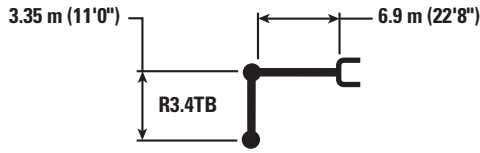

		3000 mm/120 in		4500 mm/180 in		6000 mm/240 in		7500 mm/300 in		9000 mm/360 in		mm inch		
9000 mm 360 in	kg lb											*8300 *18,400	*8300 *18,400	7320 290
7500 mm 300 in	kg lb							*9950 *21,850	*9950 *21,850			*7800 *17,250	*7800 *17,250	8490 340
6000 mm 240 in	kg lb							*10 400 *22,700	*10 400 *22,700	*9750 8750	7850 16,850	*7650 *16,900	7450 16,550	9280 370
4500 mm 180 in	kg lb			*17 400 *37,300	*17 400 *37,300	*13 350 *28,800	*13 350 *28,800	*11 250 *24,450	10 250 22,050	*10 050 *21,900	7700 16,550	*7750 *17,050	6700 14,850	9770 390
3000 mm 120 in	kg lb			*21 300 *45,700	20 200 43,650	*15 200 *32,800	13 450 29,000	*12 250 *26,500	9800 21,050	*10 500 *22,850	7450 16,050	*8100 *17,750	6350 13,950	10 010 400
1500 mm 60 in	kg lb			*17 600 *42,100	*17 600 41,000	*16 600 *35,900	12 750 27,450	*13 050 *28,300	9350 20,200	10 600 22,800	7250 15,600	*8650 *19,050	6200 13,650	10 020 400
0 mm 0 in	kg lb			*19 900 *46,150	18 600 40,050	*17 250 *37,300	12 300 26,550	*13 500 29,150	9100 19,550	10 400 22,450	7100 15,250	9250 20,400	6300 13,900	9800 390
-1500 mm -60 in	kg lb	*14 200 *32,050	*14 200 *32,050	*22 350 *48,550	18 550 39,900	*16 950 *36,750	12 150 26,150	*13 350 28,800	8950 19,250	10 350 22,300	7000 15,150	9900 21,800	6700 14,800	9320 370
-3000 mm -120 in	kg lb	*22 650 *51,200	*22 650 *51,200	*20 250 *43,900	18 750 40,300	*15 750 *34,000	12 200 26,250	*12 350 *26,600	8950 19,350			*10 200 *22,400	7600 16,750	8560 340
-4500 mm -180 in	kg lb	*21 150 *45,550	*21 150 *45,550	*16 800 *36,100	*16 800 *36,100	*13 150 *28,150	12 450 26,850					*9850 *21,600	9400 20,950	7420 290



ISO 10567



\*Indicates that the load is limited by hydraulic lifting capacity rather than tipping load. The above loads are in compliance with hydraulic excavator lift capacity standard ISO 10567:2007. They do not exceed 87% of hydraulic lifting capacity or 75% of tipping load. Weight of all lifting accessories must be deducted from the above lifting capacities. Lifting capacities are based on the machine standing on a firm, uniform supporting surface. The use of a work tool attachment point to handle/lift objects, could affect the machine lift performance.

Lift capacity stays with ±5% for all available track shoes.

Always refer to the appropriate Operation and Maintenance Manual for specific product information.



# 349D2/D2 L Hydraulic Excavator Specifications

## Mass Boom (Standard Fix Undercarriage) Lift Capacities – Counterweight: 9.0 mt (9.9 t) – Heavy Lift: Off

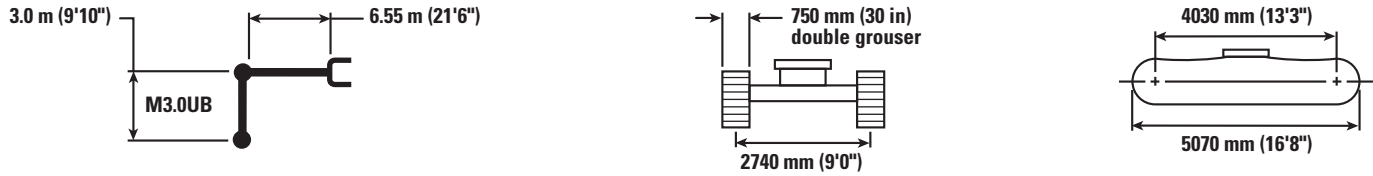

		3000 mm/120 in		4500 mm/180 in		6000 mm/240 in		7500 mm/300 in		9000 mm/360 in		mm inch		
7500 mm 300 in	kg lb							*10 600 *23,400	10 450 22,150			*9200 *20,350	*9200 *20,350	7680 300
6000 mm 240 in	kg lb							*10 700 *23,400	10 300 22,150			*8950 *19,700	8250 18,350	8540 340
4500 mm 180 in	kg lb			*17 400 *37,350	*17 400 *37,350	*13 400 *29,000	*13 400 *29,000	*11 400 *24,750	9950 21,400	*9950 7400	7200	*9050 *19,900	7300 16,100	9080 360
3000 mm 120 in	kg lb			*21 100 *45,300	19 950 43,000	*15 150 *32,700	13 150 28,400	*12 250 *26,550	9500 20,450	10 600 22,700	7200 15,450	*9450 *20,750	6800 14,950	9330 370
1500 mm 60 in	kg lb			*21 700 *49,800	18 700 40,300	*16 450 *35,550	12 450 26,850	*12 950 *28,100	9100 19,600	10 350 22,300	7000 15,050	9800 21,600	6600 14,550	9340 370
0 mm 0 in	kg lb			*23 000 *49,900	18 300 39,350	*16 950 *36,650	12 050 25,900	*13 250 *28,600	8850 19,000	10 200 6850		10 050 22,150	6750 14,900	9100 360
-1500 mm -60 in	kg lb	*17 050 *38,550	*17 050 *38,550	*21 700 *47,100	18 250 39,250	*16 450 *35,650	11 900 25,600	*12 900 *27,800	8700 18,800			*10 700 *23,550	7300 16,100	8590 340
-3000 mm -120 in	kg lb	*24 650 *53,550	*24 650 *53,550	*19 200 *41,600	18 500 39,750	*14 850 *32,050	12 000 25,800	*11 300 *23,950	8850 19,100			*10 650 *23,400	8500 18,800	7750 310
-4500 mm -180 in	kg lb			*14 900 *31,800	*14 900 *31,800	*11 250 *23,600	*11 250 *23,600					*9950 *21,700	*9950 *21,700	6460 260



ISO 10567



\*Indicates that the load is limited by hydraulic lifting capacity rather than tipping load. The above loads are in compliance with hydraulic excavator lift capacity standard ISO 10567:2007. They do not exceed 87% of hydraulic lifting capacity or 75% of tipping load. Weight of all lifting accessories must be deducted from the above lifting capacities. Lifting capacities are based on the machine standing on a firm, uniform supporting surface. The use of a work tool attachment point to handle/lift objects, could affect the machine lift performance.









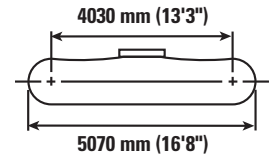
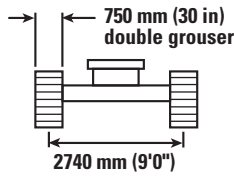
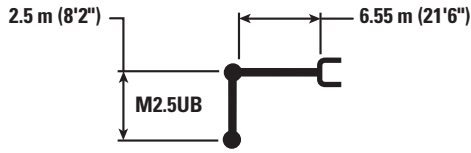

Lift capacity stays with ±5% for all available track shoes.

Always refer to the appropriate Operation and Maintenance Manual for specific product information.

# 349D2/D2 L Hydraulic Excavator Specifications

## Mass Boom (Standard Fix Undercarriage) Lift Capacities – Counterweight: 9.0 mt (9.9 t) – Heavy Lift: Off



		3000 mm/120 in		4500 mm/180 in		6000 mm/240 in		7500 mm/300 in				mm inch
												
7500 mm 300 in	kg lb									*11 600 *25,650	11 300 25,400	7120 280
6000 mm 240 in	kg lb					*12 750 *27,700	*12 750 *27,700	*11 400 *25,000	10 200 21,950	*11 200 *24,700	9050 20,200	8040 320
4500 mm 180 in	kg lb			*18 900 *40,450	*18 900 *40,450	*14 250 *30,750	13 850 29,900	*12 000 *26,050	9900 21,300	*11 100 *24,400	7950 17,550	8610 340
3000 mm 120 in	kg lb			*48,100	42,050	*15 800 *34,150	13 050 28,150	*12 750 *27,600	9500 20,450	10 800 23,850	7350 16,250	8880 350
1500 mm 60 in	kg lb					*16 900 *36,500	12 450 26,800	*13 300 *28,800	9150 19,700	10 600 23,400	7200 15,850	8890 350
0 mm 0 in	kg lb			*22 650 *49,200	18 450 39,650	*17 050 *36,950	12 100 26,100	13 400 28,800	8900 19,200	10 950 24,150	7400 16,250	8630 340
-1500 mm -60 in	kg lb	*17 250 *39,300	*17 250 *39,300	*20 900 *45,450	18 550 39,800	*16 250 *35,150	12 050 25,950	*12 650 *27,300	8900 19,150	*11 350 *25,000	8050 17,800	8090 320
-3000 mm -120 in	kg lb	*21 500 *46,850	*21 500 *46,850	*18 000 *38,950	*18 000 *38,950	*14 150 *30,400	12 200 26,350			*11 100 *24,350	9600 21,300	7200 290
-4500 mm -180 in	kg lb			*12 850 *27,200	*12 850 *27,200					*9750 *21,200	*9750 *21,200	5780 230



ISO 10567



\*Indicates that the load is limited by hydraulic lifting capacity rather than tipping load. The above loads are in compliance with hydraulic excavator lift capacity standard ISO 10567:2007. They do not exceed 87% of hydraulic lifting capacity or 75% of tipping load. Weight of all lifting accessories must be deducted from the above lifting capacities. Lifting capacities are based on the machine standing on a firm, uniform supporting surface. The use of a work tool attachment point to handle/lift objects, could affect the machine lift performance.

Lift capacity stays with ±5% for all available track shoes.

Always refer to the appropriate Operation and Maintenance Manual for specific product information.



# 349D2/D2 L Hydraulic Excavator Specifications

## Reach Boom (Long Fix Undercarriage) Lift Capacities – Counterweight: 9.0 mt (9.9 t) – Heavy Lift: Off

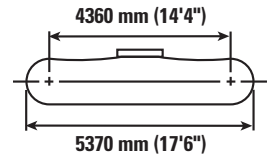
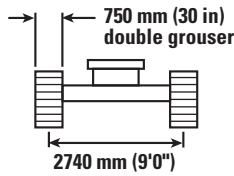
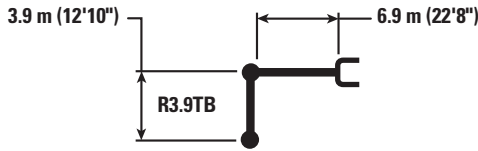

		1500 mm/60 in		3000 mm/120 in		4500 mm/180 in		6000 mm/240 in		7500 mm/300 in		9000 mm/360 in		mm inch		
9000 mm 360 in	kg lb													*7250 *16,100	*7250 *16,100	7860 310
7500 mm 300 in	kg lb													*6950 *15,300	*6950 *15,300	8970 350
6000 mm 240 in	kg lb								*9750 *21,200	*9750 *21,200	*9150 *20,000	8050 17,250	*6850 *15,100	*6850 *15,100	9720 380	
4500 mm 180 in	kg lb							*12 450 *26,850	*12 450 *26,850	*10 650 *23,100	10 450 22,450	*9550 *20,850	7850 16,850	*7000 *15,350	6400 14,100	10 190 400
3000 mm 120 in	kg lb					*19 750 *42,450	*19 750 *42,450	*14 400 *31,050	13 750 29,650	*11 700 *25,350	9950 21,400	*10 100 *22,000	7550 16,300	*7300 *16,050	6000 13,250	10 420 410
1500 mm 60 in	kg lb					*22 550 *48,700	19 450 41,900	*16 050 *34,650	12 950 27,900	*12 650 *27,400	9500 20,450	*10 650 *23,100	7300 15,750	*7850 *17,250	5850 12,900	10 430 410
0 mm 0 in	kg lb			*19,450	*19,450	*22 500 *50,750	18 750 40,300	*16 950 *36,750	12 400 26,750	*13 300 *28,750	9150 19,700	*10 950 *23,750	7100 15,300	*8700 *19,100	5950 13,050	10 220 410
-1500 mm -60 in	kg lb			*14 500 *32,650	*14 500 *32,650	*22 900 *49,650	18 550 39,850	*17 050 *36,900	12 150 26,200	*13 400 *28,950	8950 19,250	*10 850 *23,450	7000 15,050	*9750 *21,450	6250 13,800	9770 390
-3000 mm -120 in	kg lb	*36,550	*36,550	*21 150 *47,700	*21 150 *47,700	*21 250 *46,050	18 600 40,000	*16 200 *35,050	12 100 26,100	*12 750 *27,500	8900 19,200	*10 000 7000	*9900 *21,800	6950 15,400	9050 360	
-4500 mm -180 in	kg lb			*24 300 *52,400	*24 300 *52,400	*18 350 *39,550	*18 350 *39,550	*14 250 *30,550	12 300 26,500	*10 950 *23,200	9050 19,600		*9900 *21,750	8400 18,700	7970 320	
-6000 mm -240 in	kg lb					*13 450 *28,300	*13 450 *28,300	*10 150 *20,900	*10 150 *20,900				*9200 *20,100	*9200 *20,100	6380 250	



ISO 10567



\*Indicates that the load is limited by hydraulic lifting capacity rather than tipping load. The above loads are in compliance with hydraulic excavator lift capacity standard ISO 10567:2007. They do not exceed 87% of hydraulic lifting capacity or 75% of tipping load. Weight of all lifting accessories must be deducted from the above lifting capacities. Lifting capacities are based on the machine standing on a firm, uniform supporting surface. The use of a work tool attachment point to handle/lift objects, could affect the machine lift performance.

Lift capacity stays with ±5% for all available track shoes.

Always refer to the appropriate Operation and Maintenance Manual for specific product information.

# 349D2/D2 L Hydraulic Excavator Specifications

## Reach Boom (Long Fix Undercarriage) Lift Capacities – Counterweight: 9.0 mt (9.9 t) – Heavy Lift: Off

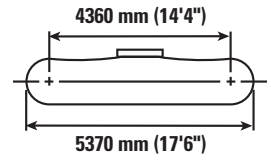
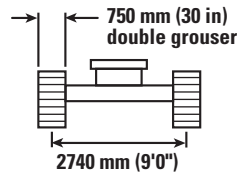
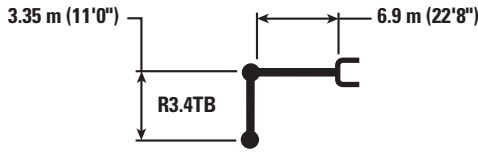

		3000 mm/120 in		4500 mm/180 in		6000 mm/240 in		7500 mm/300 in		9000 mm/360 in		mm inch		
9000 mm 360 in	kg lb											*8300 *18,450	*8300 *18,450	7300 290
7500 mm 300 in	kg lb							*9950 *21,850	*9950 *21,850			*7800 *17,250	*7800 *17,250	8490 330
6000 mm 240 in	kg lb							*10 400 *22,650	*10 400 *22,650	*9750 *18,650	7900 16,950	*7650 *16,900	7500 16,700	9280 370
4500 mm 180 in	kg lb			*17 350 *37,250	*17 350 *37,250	*13 300 *28,750	*13 300 *28,750	*11 250 *24,400	10 300 22,150	*10 050 *21,900	7750 16,650	*7750 *17,050	6750 14,950	9770 390
3000 mm 120 in	kg lb			*21 250 *45,650	20 350 43,950	*15 200 *32,750	13 550 29,200	*12 250 *26,500	9850 21,200	*10 500 *22,850	7550 16,200	*8100 *17,750	6400 14,050	10 010 400
1500 mm 60 in	kg lb			*17 600 *42,150	*17 600 41,300	*16 600 *35,900	12 850 27,650	*13 050 *28,300	9450 20,350	*10 950 *23,700	7300 15,700	*8650 *19,000	6250 13,750	10 020 400
0 mm 0 in	kg lb			*19 850 *46,050	18 750 40,300	*17 250 *37,300	12 400 26,700	*13 500 *29,250	9150 19,700	*11 100 *24,000	7150 15,350	*9550 *21,050	6350 14,000	9800 390
-1500 mm -60 in	kg lb	*14 100 *31,900	*14 100 *31,900	*22 350 *48,550	18 700 40,200	*16 950 *36,750	12 250 26,350	*13 350 *28,900	9000 19,400	*10 700 *23,050	7050 15,250	*10 150 *22,350	6750 14,900	9330 370
-3000 mm -120 in	kg lb	*22 600 *51,000	*22 600 *51,000	*20 300 *43,950	18 900 40,550	*15 750 *34,050	12 250 26,450	*12 400 *26,600	9050 19,500			*10 200 *22,400	7650 16,850	8570 340
-4500 mm -180 in	kg lb	*21 200 *45,650	*21 200 *45,650	*16 850 *36,200	*16 850 *36,200	*13 200 *28,200	12 550 27,050					*9850 *21,650	9450 21,050	7430 290



ISO 10567



\*Indicates that the load is limited by hydraulic lifting capacity rather than tipping load. The above loads are in compliance with hydraulic excavator lift capacity standard ISO 10567:2007. They do not exceed 87% of hydraulic lifting capacity or 75% of tipping load. Weight of all lifting accessories must be deducted from the above lifting capacities. Lifting capacities are based on the machine standing on a firm, uniform supporting surface. The use of a work tool attachment point to handle/lift objects, could affect the machine lift performance.

Lift capacity stays with ±5% for all available track shoes.

Always refer to the appropriate Operation and Maintenance Manual for specific product information.



# 349D2/D2 L Hydraulic Excavator Specifications

## Reach Boom (Long Fix Undercarriage) Lift Capacities – Counterweight: 9.0 mt (9.9 t) – Heavy Lift: Off

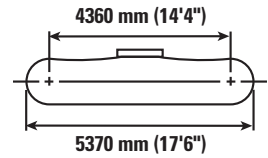
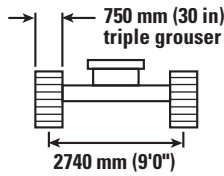
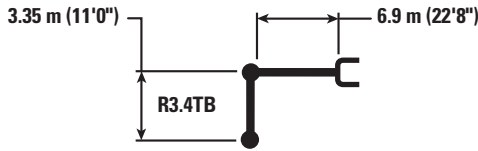

		3000 mm/120 in		4500 mm/180 in		6000 mm/240 in		7500 mm/300 in		9000 mm/360 in		mm inch		
9000 mm 360 in	kg lb											*8300 *18,450	*8300 *18,450	7300 290
7500 mm 300 in	kg lb							*9950 *21,850	*9950 *21,850			*7800 *17,250	*7800 *17,250	8490 330
6000 mm 240 in	kg lb							*10 400 *22,650	*10 400 *22,650	*9750 *18,650	7900 16,900	*7650 *16,900	7500 16,650	9280 370
4500 mm 180 in	kg lb			*17 350 *37,250	*17 350 *37,250	*13 300 *28,750	*13 300 *28,750	*11 250 *24,400	10 250 22,100	*10 050 *21,900	7750 16,600	*7750 *17,050	6750 14,900	9770 390
3000 mm 120 in	kg lb			*21 250 *45,650	20 300 43,850	*15 200 *32,750	13 500 29,150	*12 250 *26,500	9800 21,150	*10 500 *22,850	7500 16,150	*8100 *17,750	6350 14,000	10 010 400
1500 mm 60 in	kg lb			*17 600 *42,150	*17 600 41,150	*16 600 *35,900	12 800 27,600	*13 050 *28,300	9400 20,300	*10 950 *23,700	7300 15,650	*8650 *19,000	6200 13,700	10 020 400
0 mm 0 in	kg lb			*19 850 *46,050	18 700 40,200	*17 250 *37,300	12 350 26,650	*13 500 *29,250	9100 19,650	*11 100 *24,000	7100 15,300	*9550 *21,050	6350 13,950	9800 390
-1500 mm -60 in	kg lb	*14 100 *31,900	*14 100 *31,900	*22 350 *48,550	18 650 40,100	*16 950 *36,750	12 200 26,250	*13 350 *28,900	9000 19,350	*10 700 *23,050	7050 15,200	*10 150 *22,350	6750 14,850	9330 370
-3000 mm -120 in	kg lb	*22 600 *51,000	*22 600 *51,000	*20 300 *43,950	18 850 40,450	*15 750 *34,050	12 250 26,350	*12 400 *26,600	9000 19,450			*10 200 *22,400	7600 16,800	8570 340
-4500 mm -180 in	kg lb	*21 200 *45,650	*21 200 *45,650	*16 850 *36,200	*16 850 *36,200	*13 200 *28,200	12 500 26,950					*9850 *21,650	9400 21,000	7430 290



ISO 10567



\*Indicates that the load is limited by hydraulic lifting capacity rather than tipping load. The above loads are in compliance with hydraulic excavator lift capacity standard ISO 10567:2007. They do not exceed 87% of hydraulic lifting capacity or 75% of tipping load. Weight of all lifting accessories must be deducted from the above lifting capacities. Lifting capacities are based on the machine standing on a firm, uniform supporting surface. The use of a work tool attachment point to handle/lift objects, could affect the machine lift performance.

Lift capacity stays with ±5% for all available track shoes.

Always refer to the appropriate Operation and Maintenance Manual for specific product information.

# 349D2/D2 L Hydraulic Excavator Specifications

## 349D2 L Bucket Specifications and Compatibility

	Linkage	Width		Capacity		Weight		Fill %	349D2 L – 750 TG					
		mm	in	m <sup>3</sup>	yd <sup>3</sup>	kg	lb		ME Boom		Reach Boom			
									M2.5	M3.0	R2.9	R3.35	R3.9	
<b>Without Pin Grabber Coupler</b>														
General Duty (GD)	TB	1370	54	1.87	2.44	1755	3,868	100%			●	●	●	
	UB	1450	58	2.39	3.13	2324	5,122	100%	●	⊙				
	UB	1550	62	2.61	3.41	2418	5,329	100%	⊙	⊖				
	UB	2000	80	3.60	4.71	2881	6,350	100%	○	◇*				
	UB	1950	77	3.43	4.48	2725	6,006	100%	○	○				
General Duty (GDC)	TB	750	30	0.95	1.24	1311	2,889	100%			●	●	●	
	TB	900	36	1.23	1.60	1441	3,176	100%			●	●	●	
	TB	1050	42	1.51	1.98	1525	3,361	100%			●	●	●	
	TB	1200	48	1.80	2.36	1676	3,694	100%			●	●	●	
	TB	1350	54	2.10	2.74	1792	3,950	100%			●	●	⊙	
	TB	1500	60	2.39	3.13	1943	4,282	100%			●	⊙	⊖	
	TB	1700	68	2.78	3.64	2128	4,690	100%			⊖	⊖	○	
	TB	1850	74	3.08	4.04	2254	4,968	100%			⊖	○	○	
General Duty XL (GDXL)	TB	2000	80	3.82	5.00	2457	5,415	100%			◇	◇	◇	
General Duty Wide Tip (GDC-WT)	TB	900	36	1.35	1.77	1505	3,317	100%			●	●	●	
	TB	1350	54	2.22	2.90	1951	4,300	100%			●	⊙	⊙	
	TB	1500	60	2.52	3.29	2067	4,556	100%			⊙	⊖	⊖	
	TB	1650	66	2.81	3.68	2233	4,922	100%			⊖	⊖	○	
	TB	1800	72	3.11	4.07	2350	5,179	100%			○	○	○	
	TB	1950	78	3.41	4.46	2516	5,545	100%			○	◇	◇	
Heavy Duty (HD)	TB	900	36	1.08	1.41	1594	3,513	100%			●	●	●	
	TB	1050	42	1.34	1.75	1684	3,712	100%			●	●	●	
	TB	1200	48	1.60	2.09	1834	4,043	100%			●	●	●	
	TB	1350	54	1.87	2.44	1962	4,324	100%			●	●	●	
	TB	1500	60	2.41	3.16	2065	4,551	100%			⊙	⊙	⊖	
	TB	1500	60	2.14	2.80	2125	4,684	100%			●	⊙	⊙	
	TB	1650	66	2.41	3.15	2210	4,871	100%			⊙	⊖	⊖	
	TB	1650	66	2.41	3.15	2286	5,039	100%			⊙	⊖	⊖	
	TB	1650	66	2.41	3.16	2259	4,979	100%			⊙	⊖	⊖	
	TB	1800	72	2.69	3.52	2423	5,340	100%			⊖	⊖	○	
	TB	1850	74	2.78	3.64	2420	5,334	100%			⊖	○	○	
	TB	1850	73	2.69	3.52	2387	5,261	100%			⊖	⊖	○	
	TB	1850	73	2.69	3.52	2401	5,292	100%			⊖	⊖	○	
	TB	900	36	1.077	1.41	1563	3,445	100%			●	●	●	
	TB	1050	42	1.337	1.75	1655	3,648	100%			●	●	●	
	TB	1200	48	1.600	2.09	1814	3,998	100%			●	●	●	
	TB	1350	54	1.868	2.44	1941	4,278	100%			●	●	●	
	TB	1500	60	2.140	2.80	2104	4,637	100%			●	⊙	⊙	
	TB	1650	66	2.414	3.16	2266	4,994	100%			⊙	⊖	⊖	
	(continued)	TB	1800	72	2.692	3.52	2395	5,279	100%			⊖	⊖	○
	Maximum load pin-on (payload + bucket)								kg	7645	6929	6983	6523	6114
								lb	16,850	15,272	15,391	14,377	13,475	

The above loads are in compliance with hydraulic excavator standard EN474, they do not exceed 87% of hydraulic lifting capacity or 75% of tipping capacity with front linkage fully extended at ground line with bucket curled.

Capacity based on ISO 7451.

Bucket weight with Long tips.

\*For light dirt applications only. Consult your dealer to understand your application before using this bucket in combination with this stick.

### Maximum Material Density:

- 2100 kg/m<sup>3</sup> (3,500 lb/yd<sup>3</sup>)
- ⊙ 1800 kg/m<sup>3</sup> (3,000 lb/yd<sup>3</sup>)
- ⊖ 1500 kg/m<sup>3</sup> (2,500 lb/yd<sup>3</sup>)
- 1200 kg/m<sup>3</sup> (2,000 lb/yd<sup>3</sup>)
- ◇ 900 kg/m<sup>3</sup> (1,500 lb/yd<sup>3</sup>)

Caterpillar recommends using appropriate work tools to maximize the value customers receive from our products. Use of work tools, including buckets, which are outside of Caterpillar's recommendations or specifications for weight, dimensions, flows, pressures, etc. may result in less-than-optimal performance, including but not limited to reductions in production, stability, reliability, and component durability. Improper use of a work tool resulting in sweeping, prying, twisting and/or catching of heavy loads will reduce the life of the boom and stick.

# 349D2/D2 L Hydraulic Excavator Specifications

## 349D2 L Bucket Specifications and Compatibility

	Linkage	Width		Capacity		Weight		Fill	349D2 L – 750 TG				
		mm	in	m <sup>3</sup>	yd <sup>3</sup>	kg	lb		ME Boom		Reach Boom		
									M2.5	M3.0	R2.9	R3.35	R3.9
<b>Without Pin Grabber Coupler (continued)</b>													
Heavy Duty (HD) (continued)	TB	1200	48	1.49	1.95	1930	4,254	100%			●	●	●
	TB	1350	54	1.74	2.27	2063	4,547	100%			●	●	●
	TB	1500	60	1.98	2.59	2233	4,922	100%			●	●	⊙
	TB	1650	66	2.23	2.91	2403	5,296	100%			⊙	⊙	⊖
	TB	1850	74	2.56	3.34	2585	5,697	100%			⊖	⊖	○
	UB	1650	65	2.77	3.62	2562	5,647	100%	⊙	⊖			
	UB	1850	73	3.19	4.16	2735	6,028	100%	⊖	○			
	UB	1950	77	3.43	4.48	2898	6,387	100%	○	◇			
Severe Duty (SD)	TB	750	30	0.88	1.15	1446	3,187	90%			●	●	●
	TB	900	36	1.08	1.41	1677	3,696	90%			●	●	●
	TB	1050	42	1.34	1.75	1 79	3,921	90%			●	●	●
	TB	1200	48	1.60	2.09	1952	4,302	90%			●	●	●
	TB	1400	55	1.87	2.44	2180	4,805	90%			●	●	●
	TB	1550	61	2.14	2.80	2340	5,157	90%			●	●	⊙
	TB	1550	61	2.14	2.80	2381	5,248	90%			●	●	⊙
	TB	1700	67	2.41	3.16	2524	5,563	90%			⊙	⊙	⊖
	TB	1700	67	2.41	3.16	2494	5,497	90%			⊙	⊙	⊖
	TB	1850	74	2.69	3.52	2726	6,008	90%			⊖	⊖	○
	TB	1900	75	2.78	3.64	2716	5,986	90%			⊖	⊖	○
	TB	1200	48	1.60	2.09	1946	4,289	90%			●	●	●
	TB	1560	61	2.14	2.80	2198	4,844	90%			●	●	⊙
	TB	1694	66	2.41	3.16	2444	5,387	90%			⊙	⊙	⊖
	TB	1400	55	1.87	2.44	2157	4,754	90%			●	●	●
	UB	1450	58	2.39	3.13	2540	5,598	90%	●	⊙			
	UB	1550	62	2.61	3.41	2648	5,836	90%	●	⊙			
	UB	1650	65	2.77	3.62	2729	6,015	90%	⊙	⊖			
	UB	1850	73	3.21	4.20	2987	6,583	90%	⊖	○			
	UB	1950	77	3.43	4.48	3058	6,740	90%	○	○			
	UB	1550	62	2.61	3.41	2610	5,752	90%	●	⊙			
	UB	1850	73	3.21	4.20	2937	6,473	90%	⊖	○			
	Severe Duty Power (SDP)	TB	1750	70	2.40	3.14	2454	5,409	90%			⊙	⊙
Extreme Duty (XD)	TB	1250	49	1.60	2.09	2224	4,902	90%			●	●	●
	TB	1400	55	1.87	2.44	2366	5,215	90%			●	●	●
	TB	1700	67	2.41	3.15	2765	6,094	90%			⊙	⊖	⊖
	UB	1550	62	2.61	3.41	3091	6,813	90%	⊙	⊖			
	UB	1650	65	2.77	3.62	3192	7,035	90%	⊖	○			
	UB	1550	62	2.61	3.41	3142	6,925	90%	⊙	⊖			
Maximum load pin-on (payload + bucket)								kg	7645	6929	6983	6523	6114
								lb	16,850	15,272	15,391	14,377	13,475

### Maximum Material Density:

- 2100 kg/m<sup>3</sup> (3,500 lb/yd<sup>3</sup>)
- ⊙ 1800 kg/m<sup>3</sup> (3,000 lb/yd<sup>3</sup>)
- ⊖ 1500 kg/m<sup>3</sup> (2,500 lb/yd<sup>3</sup>)
- 1200 kg/m<sup>3</sup> (2,000 lb/yd<sup>3</sup>)
- ◇ 900 kg/m<sup>3</sup> (1,500 lb/yd<sup>3</sup>)

The above loads are in compliance with hydraulic excavator standard EN474, they do not exceed 87% of hydraulic lifting capacity or 75% of tipping capacity with front linkage fully extended at ground line with bucket curled.

Capacity based on ISO 7451.

Bucket weight with Long tips.

Caterpillar recommends using appropriate work tools to maximize the value customers receive from our products. Use of work tools, including buckets, which are outside of Caterpillar's recommendations or specifications for weight, dimensions, flows, pressures, etc. may result in less-than-optimal performance, including but not limited to reductions in production, stability, reliability, and component durability. Improper use of a work tool resulting in sweeping, prying, twisting and/or catching of heavy loads will reduce the life of the boom and stick.



# 349D2/D2 L Hydraulic Excavator Specifications

## 349D2 L Bucket Specifications and Compatibility

	Linkage	Width		Capacity		Weight		Fill	349D2 L – 750 TG								
		mm	in	m <sup>3</sup>	yd <sup>3</sup>	kg	lb		%	ME Boom		Reach Boom					
										M2.5	M3.0	R2.9 HD	R3.35 HD	R3.9 HD			
<b>With Pin Grabber Quick Coupler</b>																	
General Duty (GD)	TB	1370	54	1.87	2.44	1755	3,868	100%			●	●	●				
	UB	1450	58	2.39	3.13	2324	5,122	100%	●	⊙							
	UB	1550	62	2.61	3.41	2418	5,329	100%	⊙	⊖							
	UB	2000	80	3.60	4.71	2881	6,350	100%	○	◇*							
	UB	1950	77	3.43	4.48	2725	6,006	100%	○	○							
General Duty (GDC)	TB	750	30	0.95	1.24	1311	2,889	100%			●	●	●				
	TB	900	36	1.23	1.60	1441	3,176	100%			●	●	●				
	TB	1050	42	1.51	1.98	1525	3,361	100%			●	●	●				
	TB	1200	48	1.80	2.36	1676	3,694	100%			●	●	●				
	TB	1350	54	2.10	2.74	1792	3,950	100%			●	●	⊙				
	TB	1500	60	2.39	3.13	1943	4,282	100%			●	⊙	⊖				
	TB	1700	68	2.78	3.64	2128	4,690	100%			⊖	⊖	○				
	TB	1850	74	3.08	4.04	2254	4,968	100%			⊖	○	○				
General Duty XL (GDXL)	TB	2000	80	3.82	5.00	2457	5,415	100%			◇	◇	◇				
General Duty Wide Tip (GDC-WT)	TB	900	36	1.35	1.77	1505	3,317	100%			●	●	●				
	TB	1350	54	2.22	2.90	1951	4,300	100%			●	⊙	⊙				
	TB	1500	60	2.52	3.29	2067	4,556	100%			⊙	⊖	⊖				
	TB	1650	66	2.81	3.68	2233	4,922	100%			⊖	⊖	○				
	TB	1800	72	3.11	4.07	2350	5,179	100%			○	○	○				
	TB	1950	78	3.41	4.46	2516	5,545	100%			○	◇	◇				
Heavy Duty (HD)	TB	900	36	1.08	1.41	1594	3,513	100%			●	●	●				
	TB	1050	42	1.34	1.75	1684	3,712	100%			●	●	●				
	TB	1200	48	1.60	2.09	1834	4,043	100%			●	●	●				
	TB	1350	54	1.87	2.44	1962	4,324	100%			●	●	●				
	TB	1500	60	2.41	3.16	2065	4,551	100%			⊙	⊙	⊖				
	TB	1500	60	2.14	2.80	2125	4,684	100%			●	⊙	⊙				
	TB	1650	66	2.41	3.15	2210	4,871	100%			⊙	⊖	⊖				
	TB	1650	66	2.41	3.15	2286	5,039	100%			⊙	⊖	⊖				
	TB	1650	66	2.41	3.16	2259	4,979	100%			⊙	⊖	⊖				
	TB	1800	72	2.69	3.52	2423	5,340	100%			⊖	⊖	○				
	TB	1850	74	2.78	3.64	2420	5,334	100%			⊖	○	○				
	TB	1850	73	2.69	3.52	2387	5,261	100%			⊖	⊖	○				
	TB	1850	73	2.69	3.52	2401	5,292	100%			⊖	⊖	○				
	TB	900	36	1.077	1.41	1563	3,445	100%			●	●	●				
	TB	1050	42	1.337	1.75	1655	3,648	100%			●	●	●				
	TB	1200	48	1.600	2.09	1814	3,998	100%			●	●	●				
	TB	1350	54	1.868	2.44	1941	4,278	100%			●	●	●				
	TB	1500	60	2.140	2.80	2104	4,637	100%			●	⊙	⊙				
	TB	1650	66	2.414	3.16	2266	4,994	100%			⊙	⊖	⊖				
	(continued)	TB	1800	72	2.692	3.52	2395	5,279	100%			⊖	⊖	○			
	Maximum load pin-on (payload + bucket)								kg	6812	6096	6150	5690	5281			
									lb	15,014	13,436	13,555	12,541	11,639			

The above loads are in compliance with hydraulic excavator standard EN474, they do not exceed 87% of hydraulic lifting capacity or 75% of tipping capacity with front linkage fully extended at ground line with bucket curled.

Capacity based on ISO 7451.

Bucket weight with Long tips.

\*For light dirt applications only. Consult your dealer to understand your application before using this bucket in combination with this stick.

### Maximum Material Density:

- 2100 kg/m<sup>3</sup> (3,500 lb/yd<sup>3</sup>)
- ⊙ 1800 kg/m<sup>3</sup> (3,000 lb/yd<sup>3</sup>)
- ⊖ 1500 kg/m<sup>3</sup> (2,500 lb/yd<sup>3</sup>)
- 1200 kg/m<sup>3</sup> (2,000 lb/yd<sup>3</sup>)
- ◇ 900 kg/m<sup>3</sup> (1,500 lb/yd<sup>3</sup>)

Caterpillar recommends using appropriate work tools to maximize the value customers receive from our products. Use of work tools, including buckets, which are outside of Caterpillar's recommendations or specifications for weight, dimensions, flows, pressures, etc. may result in less-than-optimal performance, including but not limited to reductions in production, stability, reliability, and component durability. Improper use of a work tool resulting in sweeping, prying, twisting and/or catching of heavy loads will reduce the life of the boom and stick.

# 349D2/D2 L Hydraulic Excavator Specifications

## 349D2 L Bucket Specifications and Compatibility

	Linkage	Width		Capacity		Weight		Fill	349D2 L – 750 TG					
		mm	in	m <sup>3</sup>	yd <sup>3</sup>	kg	lb		%	ME Boom		Reach Boom		
										M2.5	M3.0	R2.9 HD	R3.35 HD	R3.9 HD
<b>With Pin Grabber Quick Coupler (continued)</b>														
Heavy Duty (HD) (continued)	TB	1200	48	1.49	1.95	1930	4,254	100%			●	●	●	
	TB	1350	54	1.74	2.27	2063	4,547	100%			●	●	●	
	TB	1500	60	1.98	2.59	2233	4,922	100%			●	●	⊙	
	TB	1650	66	2.23	2.91	2403	5,296	100%			⊙	⊙	⊖	
	TB	1850	74	2.56	3.34	2585	5,697	100%			⊖	⊖	○	
	UB	1650	65	2.77	3.62	2562	5,647	100%	⊙	⊖				
	UB	1850	73	3.19	4.16	2735	6,028	100%	⊖	○				
	UB	1950	77	3.43	4.48	2898	6,387	100%	○	◇				
Severe Duty (SD)	TB	750	30	0.88	1.15	1446	3,187	90%			●	●	●	
	TB	900	36	1.08	1.41	1677	3,696	90%			●	●	●	
	TB	1050	42	1.34	1.75	1779	3,921	90%			●	●	●	
	TB	1200	48	1.60	2.09	1952	4,302	90%			●	●	●	
	TB	1400	55	1.87	2.44	2180	4,805	90%			●	●	●	
	TB	1550	61	2.14	2.80	2340	5,157	90%			●	●	⊙	
	TB	1550	61	2.14	2.80	2381	5,248	90%			●	●	⊙	
	TB	1700	67	2.41	3.16	2524	5,563	90%			⊙	⊙	⊖	
	TB	1700	67	2.41	3.16	2494	5,497	90%			⊙	⊙	⊖	
	TB	1850	74	2.69	3.52	2726	6,008	90%			⊖	⊖	○	
	TB	1900	75	2.78	3.64	2716	5,986	90%			⊖	⊖	○	
	TB	1200	48	1.60	2.09	1946	4,289	90%			●	●	●	
	TB	1560	61	2.14	2.80	2198	4,844	90%			●	●	⊙	
	TB	1694	66	2.41	3.16	2444	5,387	90%			⊙	⊙	⊖	
	TB	1400	55	1.87	2.44	2157	4,754	90%			●	●	●	
	UB	1450	58	2.39	3.13	2540	5,598	90%	●	⊙				
	UB	1550	62	2.61	3.41	2648	5,836	90%	●	⊙				
	UB	1650	65	2.77	3.62	2729	6,015	90%	⊙	⊖				
	UB	1850	73	3.21	4.20	2987	6,583	90%	⊖	○				
	UB	1950	77	3.43	4.48	3058	6,740	90%	○	○				
	UB	1550	62	2.61	3.41	2610	5,752	90%	●	⊙				
	UB	1850	73	3.21	4.20	2937	6,473	90%	⊖	○				
	Severe Duty Power (SDP)	TB	1750	70	2.40	3.14	2454	5,409	90%			⊙	⊙	⊖
Extreme Duty (XD)	TB	1250	49	1.60	2.09	2224	4,902	90%			●	●	●	
	TB	1400	55	1.87	2.44	2366	5,215	90%			●	●	●	
	TB	1700	67	2.41	3.15	2765	6,094	90%			⊙	⊖	⊖	
	UB	1550	62	2.61	3.41	3091	6,813	90%	⊙	⊖				
	UB	1650	65	2.77	3.62	3192	7,035	90%	⊖	○				
	UB	1550	62	2.61	3.41	3142	6,925	90%	⊙	⊖				
Maximum load pin-on (payload + bucket)								kg	6812	6096	6150	5690	5281	
								lb	15,014	13,436	13,555	12,541	11,639	

The above loads are in compliance with hydraulic excavator standard EN474, they do not exceed 87% of hydraulic lifting capacity or 75% of tipping capacity with front linkage fully extended at ground line with bucket curled.

Capacity based on ISO 7451.  
Bucket weight with Long tips.

### Maximum Material Density:

- 2100 kg/m<sup>3</sup> (3,500 lb/yd<sup>3</sup>)
- ⊙ 1800 kg/m<sup>3</sup> (3,000 lb/yd<sup>3</sup>)
- ⊖ 1500 kg/m<sup>3</sup> (2,500 lb/yd<sup>3</sup>)
- 1200 kg/m<sup>3</sup> (2,000 lb/yd<sup>3</sup>)
- ◇ 900 kg/m<sup>3</sup> (1,500 lb/yd<sup>3</sup>)

Caterpillar recommends using appropriate work tools to maximize the value customers receive from our products. Use of work tools, including buckets, which are outside of Caterpillar's recommendations or specifications for weight, dimensions, flows, pressures, etc. may result in less-than-optimal performance, including but not limited to reductions in production, stability, reliability, and component durability. Improper use of a work tool resulting in sweeping, prying, twisting and/or catching of heavy loads will reduce the life of the boom and stick.

# 349D2/D2 L Hydraulic Excavator Specifications

## 349D2 L Bucket Specifications and Compatibility

	Linkage	Width		Capacity		Weight		Fill	349D2 L – 750 TG								
		mm	in	m <sup>3</sup>	yd <sup>3</sup>	kg	lb		ME Boom		Reach Boom						
									M2.5	M3.0	R2.9 HD	R3.35 HD	R3.9 HD				
<b>With Quick Coupler (CW55)</b>																	
Heavy Duty (HD)	TB	1650	66	2.41	3.15	2196	4,840	100%			⊙	⊖	⊖				
	UB	1650	65	2.77	3.62	2479	5,464	100%	⊙	⊖							
	UB	1850	73	3.19	4.16	2664	5,871	100%	⊖	○							
Severe Duty (SD)	UB	1550	62	2.61	3.41	2570	5,664	90%	●	⊙							
	UB	1650	65	2.77	3.62	2655	5,852	90%	⊙	⊖							
Extreme Duty (XD)	UB	1550	62	2.61	3.41	3087	6,804	90%	⊙	⊖							
Maximum load pin-on (payload + bucket)								kg	6805	6089	6223	5763	5354				
								lb	14,998	13,420	13,715	12,702	11,800				

### Maximum Material Density:

- 2100 kg/m<sup>3</sup> (3,500 lb/yd<sup>3</sup>)
- ⊙ 1800 kg/m<sup>3</sup> (3,000 lb/yd<sup>3</sup>)
- ⊖ 1500 kg/m<sup>3</sup> (2,500 lb/yd<sup>3</sup>)
- 1200 kg/m<sup>3</sup> (2,000 lb/yd<sup>3</sup>)
- ◇ 900 kg/m<sup>3</sup> (1,500 lb/yd<sup>3</sup>)

The above loads are in compliance with hydraulic excavator standard EN474, they do not exceed 87% of hydraulic lifting capacity or 75% of tipping capacity with front linkage fully extended at ground line with bucket curled.

Capacity based on ISO 7451.

Bucket weight with Long tips.

Caterpillar recommends using appropriate work tools to maximize the value customers receive from our products. Use of work tools, including buckets, which are outside of Caterpillar's recommendations or specifications for weight, dimensions, flows, pressures, etc. may result in less-than-optimal performance, including but not limited to reductions in production, stability, reliability, and component durability. Improper use of a work tool resulting in sweeping, prying, twisting and/or catching of heavy loads will reduce the life of the boom and stick.



# 349D2/D2 L Hydraulic Excavator Specifications

## 349D2/D2 L Work Tool Offering Guide\*

Boom Type	Reach 6.9 m (22'8")			Mass 6.55 m (21'6")	
	Reach 2.9 m (9'6")	Reach 3.35 m (11'0")	Reach 3.9 m (12'10")	Mass 2.5 m (8'2")	Mass 3.0 m (9'10")
Hydraulic Hammer	H160Es	H160Es	H160Es	H160Es	H160Es
	H180Es	H180Es **	H180Es ***	H180Es	H180Es
Multi-Processor	MP30 CC Jaw	MP30 CC Jaw	MP30 CC Jaw **	MP30 CC Jaw	MP30 CC Jaw
	MP30 CR Jaw	MP30 CR Jaw	MP30 CR Jaw **	MP30 CR Jaw	MP30 CR Jaw
	MP30 PP Jaw	MP30 PP Jaw **	MP30 PP Jaw ***	MP30 PP Jaw	MP30 PP Jaw
	MP30 PS Jaw	MP30 PS Jaw	MP30 PS Jaw **	MP30 PS Jaw	MP30 PS Jaw
	MP30 S Jaw	MP30 S Jaw	MP30 S Jaw **	MP30 S Jaw	MP30 S Jaw
	MP30 TS Jaw	MP30 TS Jaw ***	MP30 TS Jaw ***	MP30 TS Jaw	MP30 TS Jaw ^
				MP40 CC Jaw *** # MP40 CR Jaw *** # MP40 S Jaw *** #	
Crusher	P335	P335	P335 **	P335 P360 ***	P335 P360 *** #
	P235	P235	P235 **	P235	P235
Pulverizer	P235	P235	P235 **	P235	P235
Demolition and Sorting Grapple	G330	G330	G330	G330	G330
Mobile Scrap and Demolition Shear	S340B **	S340B ***	S340B ***	S340B	S340B **
	S365C ##	S365C ##	S365C ##	S365C ##	S365C ##
	S385C ##	S385C ##	S385C ##	S385C ##	S385C ##
Orange Peel Grapple					
Clamshells					
Rippers					
Center-Lock Pin Grabber Coupler					
Dedicated Quick Coupler					

These work tools are available for the 349D2 L. Consult your Cat dealer for proper match.

\* Offerings not available in all areas. Matches are dependent on excavator configurations. Consult your Cat dealer to determine what is offered in your area and for proper work tool match.

\*\* Pin-on or CW coupler

\*\*\* Pin-on only

# Over the front only

## Boom mount

^ Over the front only with CL coupler

# 349D2/D2 L Standard Equipment

## Standard Equipment

Standard equipment may vary. Consult your Cat dealer for details.

### ENGINE

- Cat C13 engine
- Meets U.S. EPA Tier 2, EU Stage II and China Tier 2 emission standards
- 2300 m (7,500 ft) altitude capability
- Radial seal air filters (primary and secondary filter)
- Glow plugs (for cold weather start)
- Automatic engine speed control with one touch low idle
- High ambient cooling package 52° C (125° F)
- Water separator with water level indicator sensor
- Waved fin radiator with space for cleaning
- Two speed travel
- Electric priming pump
- Fuel pressure differential gauge
- ECO and HHP

### HYDRAULIC SYSTEM

- Regeneration circuits for boom and stick
- Auxiliary hydraulic valve
- Reverse swing damping valve
- Automatic swing parking brake
- Boom drift reducing valve
- Boom lowering device for back-up
- Stick drift reducing valve
- Straight travel hydraulic circuit
- High performance hydraulic return filters

### CAB

- Pressurized cab
- Fully adjustable mechanical suspension seat
- Adjustable armrest
- Seat belt, retractable (51 mm [2 in] width)
- 70/30 split front windshield
- Laminated upper front windshield and tempered other windows
- Sliding upper door window
- Openable front windshield with assist device
- Pillar mounted upper windshield wiper and washer
- Bi-level air conditioner (automatic) with defroster (pressurized function)
- Color LCD display with warning, filter/fluid change, and working hour information
- Control lever joysticks
- Hydraulic activation control lever (lock out for all controls)
- Travel control pedals with removable hand levers
- Radio mounting (DIN size)
- Radio ready
- 12V – 2× maximum 10A power supply
- Two stereo speakers
- Beverage holder
- Coat hook
- Openable roof hatch
- Washable floor mat

### UNDERCARRIAGE

- Idler and center section track guiding guard
- Towing eye on base frame
- Grease lubricated track

### ELECTRICAL

- Batteries (2 × 750 CCA)
- 75 amp alternator
- 24V – 7.5 kW starter motor

### LIGHTS

- Left boom working light
- Right working light mounted in the storage box
- Interior lighting

### SAFETY & SECURITY

- Cat one key security system
- Door and compartment locks
- Signaling/warning horn
- Rearview mirrors
- Fire wall between engine and pump compartment
- Emergency engine shutoff switch
- Emergency exit rear window
- Battery disconnect switch

### COUNTERWEIGHT

- 9.0 mt (9.9 t) counterweight

### TECHNOLOGY

- Product Link
- Cat Electronic Technician data link

## Optional Equipment

Optional equipment may vary. Consult your Cat dealer for details.

### ENGINE

- Starting kit, cold weather,  $-32^{\circ}\text{C}$  ( $-25.6^{\circ}\text{F}$ ), ether or block heater
- Air prefilter

### HYDRAULIC SYSTEM

- Auxiliary hydraulics options
- Hammer circuit, foot pedal operated
- Two way combined circuit, foot pedal operated
- Two way combined circuit, joystick operated
- Two way combined circuit with medium pressure, joystick operated
- Auxiliary hydraulic lines for booms and sticks

### UNDERCARRIAGE AND GUARDS

- 600 mm (24 in) double grouser shoes
- 600 mm (24 in) triple grouser shoes
- 750 mm (30 in) double grouser shoes
- 750 mm (30 in) triple grouser shoes
- 900 mm (35 in) triple grouser shoes
- Full length track guiding guard (2 pieces)
- Guard package

### LIGHTS

- Cab mounted working lights
- Right mounted boom light for reach boom

### TECHNOLOGY

- AccuGrade™ Ready Option (ARO)

### FRONT LINKAGE

- Booms
  - Reach 6.9 m (22'8")
  - Mass 6.55 m (21'6")
- Sticks
  - Reach 2.9 m (9'6")
  - Reach 3.35 m (11'0")
  - Reach 3.9 m (12'10")
  - Mass 2.5 m (8'2")
  - Mass 3.0 m (9'10")



For more complete information on Cat products, dealer services, and industry solutions, visit us on the web at [www.cat.com](http://www.cat.com)

AEHQ7227-02 (10-2017)  
Replaces AEHQ7227-01

© 2017 Caterpillar  
All rights reserved

Materials and specifications are subject to change without notice. Featured machines in photos may include additional equipment. See your Cat dealer for available options.

CAT, CATERPILLAR, SAFETY.CAT.COM, their respective logos, "Caterpillar Yellow" and the "Power Edge" trade dress, as well as corporate and product identity used herein, are trademarks of Caterpillar and may not be used without permission.

VisionLink is a trademark of Trimble Navigation Limited, registered in the United States and in other countries.

